

86563

## GU10 LED Beam Angle 120°

### FEATURES

- 2 years warranty
- Constructed from thermoplastic & polycarbonate
- Matt white plastic & frosted pc finish
- Not used for enclosed cans

### SPEC DATA

Product Wattage:	6W
Product Lumen:	460
Lumen/W:	77
Kelvin:	3000K
Energy Rating:	A+
Dimmable:	No
Beam Angle:	120°
Operational Voltage:	220-240V
Power Factor:	>0.5
CRI:	80
Lifetime (Hours):	25000
LED Type:	SMD
SDCM:	6
Driver Type:	28mA
Product Voltage:	220-240V
Hertz:	50Hz
Surge Protection (KV):	2
Operating Temp.:	-20 to 45 Degree
Product Weight (KG):	0.023

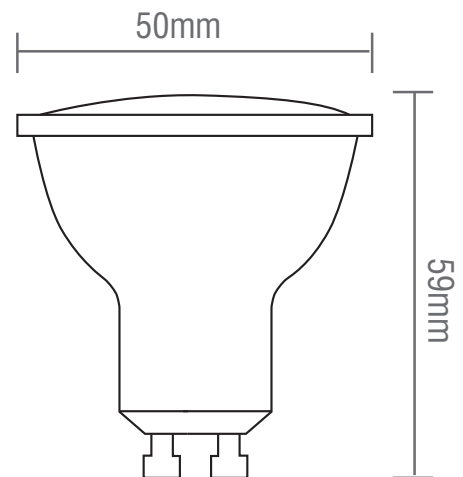

National Lighting (Genesis 1:3 LTD)

Unit 8, Grand Union Trading Estate Abbey Road, Park Royal London NW10 7UL

TEL: 0845-634-1515 E: [customerservice@nationallighting.co.uk](mailto:customerservice@nationallighting.co.uk)

[www.nationallighting.co.uk](http://www.nationallighting.co.uk)

**National Lighting**