

74711

ShieldECO

FEATURES

- 5 years (2 years + 3 years) extended warranty
- Constructed from steel & acrylic
- Chrome plate & clear acrylic finish
- Complete with integrated control gear
- Fire rated to 30, 60 & 90 minutes
- IP65. Suitable for bathroom zone 2
- Suitable for bathroom zone 1 if used in conjunction with a 30MA RCD

SPEC DATA

LED module wattage:	8.5W
Product wattage:	8.5W
Product Lumen:	750
Kelvin:	3000K
Energy Rating:	A+
Dimmable:	Yes
Beam Angle:	60°
Power Factor:	0.9
CRI:	80
Lifetime (Hours):	30000
LED Type:	SMD
SDCM:	<6
Product Voltage:	220-240V
IP Rating:	IP65
Cut out:	D57mm
Operating Temp:	-20 to 40 Degree
Product Weight (KG):	0.19
Minimum Cavity Depth (mm):	90mm
Terminal Block:	4-way Quick fit
Class:	2

ACCESSORIES

75021, Dimmer Module 150W

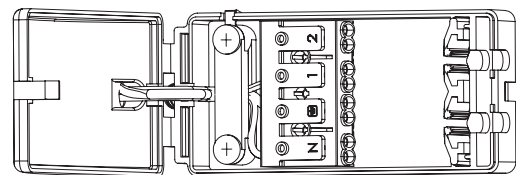
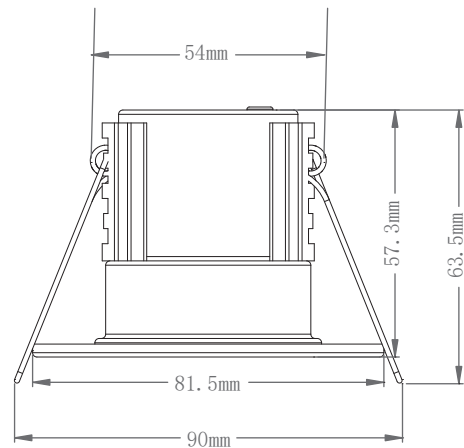

Quick fit