

## Wiring

- Unclip the cover from the quick fit connection case. Having correctly identified the wiring from your existing light fitting, pull the mains wire through the hole and connect to the connection block inside the quick fit connection case in the following way. No tools are necessary.

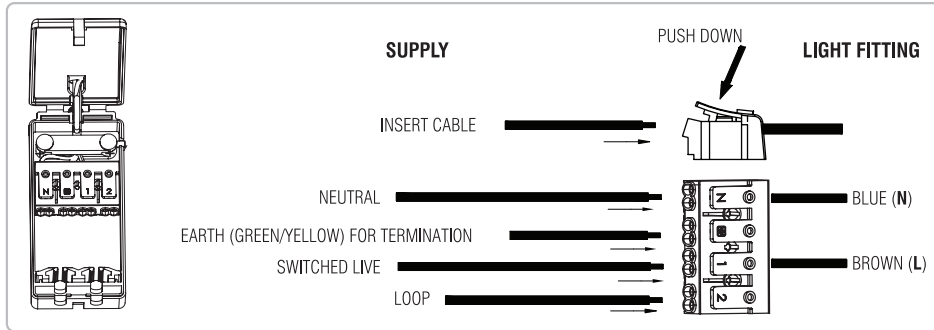

## Check that...

- You have correctly identified the wires.
- The connections are tight.
- No loose strands have been left out of the connection block.
- The cover on the connection box has been replaced.

## Fitting/Replacing the bulb

When changing a bulb, always switch off at the mains and allow the bulb to cool before handling. Dispose of used bulbs carefully. Use a soft cloth to handle bulbs, avoid directly touching the bulbs as this will shorten their life. Do not exceed the wattage stated or use a different shape bulb from that indicated on the fitting.

Max. 10W LED GU10

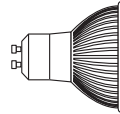

## Care and Safety

- We recommend cleaning with a soft dry cloth. Do not use solvents or abrasive cleaners as these could damage the finish.
- For your safety, always switch off the power supply before cleaning.

## Instruction leaflet

# Speculo Fire Rated Recessed Downlight



79978 / 79979 / 79980 / 99760



80247 / 80248

Thank you for purchasing this light fitting. Please read the instruction carefully before use to ensure safe and satisfactory operation of this product. Please retain these instruction for future reference.

## Warning

Please read these instructions carefully before commencing any work.

This unit must be fitted by a competent and qualified electrician.

Install in accordance with IET Wiring regulations and current Building Regulations.

Check the pack and make sure you have all of the parts listed.

To prevent electrocution switch off at mains supply before installing or maintaining this fitting. Ensure other persons cannot restore the electrical supply without your knowledge.

This light fitting should be connected to a circuit with a 30mA RCD fitted.

If replacing an existing fitting, make a careful note of the connections.







Cables must be protected using suitable conduit or trunking.

This product is suitable for indoor use only.

Do not attach to surfaces which are damp, freshly painted or otherwise electrically conductive (e.g. metallic surfaces).

This product meets the electrical installation requirements for fire-rated ceiling lamps (BS476 Part 21) and can withstand fire up to 30, 60 and 90 minutes. The fire protection is provided by a glass lens. This has been tested and has passed the relevant standards.

## Technical data

Supply Voltage:	220-240V~, 50 Hz
Bulb Type:	1 x Max. 10W LED GU10 (required)
	Conformity with all relevant UKCA Directive requirements.
	Conformity with all relevant EC Directive requirements.
	Waste electrical products should not be disposed of with household waste. Please recycle where facilities exist. Check with your Local Authority or local store for recycling advice.
	This product is NOT suitable for direct mounting on normally flammable surfaces (suitable only for mounting on non-combustible surfaces).
	Minimum distance from lighted objects (0.5 metres)
	The power supply is Double Insulated and does not require connection to an Earth circuit.
	This product is suitable for dimming.
<b>IP65</b>	Jet-proof

## Layout

- Plan the desired layout of these fittings carefully, ensuring the cables will reach the distances each light fitting.
- Avoid locating any cables in positions that would cause a hazard. Position cables and junction boxes (not supplied) away from areas where they may be at risk from being cut, trapped or damaged.
- This product is suitable for bathroom zone 1 & 2 and used in conjunction with a 30MA RCD.

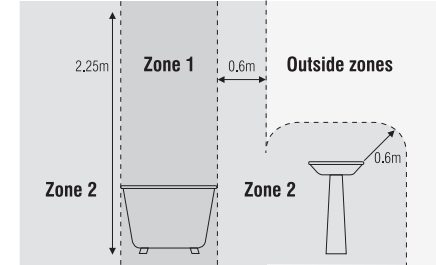

## Installation

Existing fittings must be completely removed before installation of a new product. Before removing the existing fitting, carefully note the position of each set of wires.

- Note that the switch is turned off before installation.
- The ceiling surface must be flat and smooth to ensure a good fit.
- Ensure free movement of air by removing void insulation from at least 100mm from around the hole. Under no circumstances must these fittings be covered with insulating matting or similar material.
- The unit must be located a minimum distance of 100mm from a joist.
- Cut the correct sizes hole using an appropriate tool:  
79978 / 79979 / 79980 / 99760 : Ø67mm  
80247 / 80248 : Ø75mm
- Ensure the minimum ceiling void depth is available:  
79978 / 79979 / 79980 / 99760 : 122mm  
80247 / 80248 : 157mm
- Fit the appropriate bulb into the lamp holder. NOTE: Never fit bulbs of a higher wattage than those specified on the label (as these may cause overheating and damage the fitting).
- Push the spring clips upwards and fit the two longer arms into the ceiling hole.
- Push the unit up until firmly in position, ensuring that the cable is not trapped.
- Switch on. Your light is now ready for use.

It is recommended to cut the hole slightly smaller than needed, then file the hole until the recessed unit fits snugly.

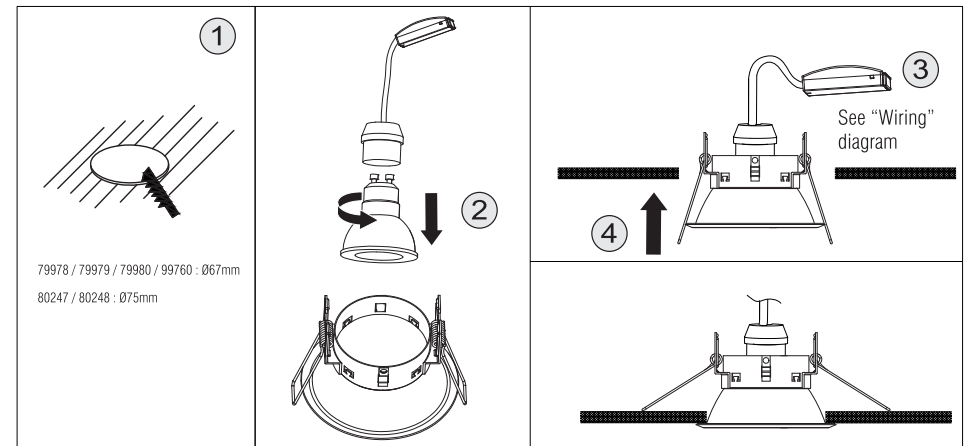

\* Product images may vary