

Wiring

This product is Class I product must be earthed. They must be joined together and well insulated with good quality insulation tape. This is to ensure earth continuity throughout your property. Having correctly identified the wiring from your existing light fitting and connect to the connection block inside the product in the way on the right:

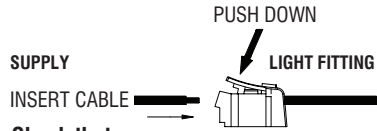

Check that...

- You have correctly identified the wires.
- The connections are tight.
- No loose strands have been left out of the connection block.

Maintained(Unswitched) Wiring :

The product on permanently and comes on during a power failure.

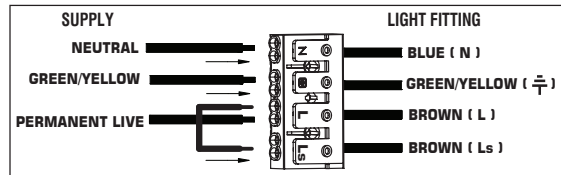

Maintained (Switched) Wiring: The product is used as a normal light - switch on/off, light turns on/off. Comes on during a power failure.

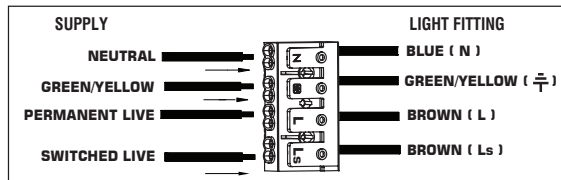

Technical data

Supply Voltage: 220-240 V~, 50 Hz

Bulb 107141 : 31.5W / 20W LED module (SMD) CCT, 3000K / 4000K / 6000K

Type: 107142 : 39W / 26W LED module (SMD) CCT, 3000K / 4000K / 6000K

107143 : 44W / 35W LED module (SMD) CCT, 3000K / 4000K / 6000K

This product contains a light source of energy efficiency class C.

  Non-replaceable light source

 Replaceable control gear by a professional

 Conformity with all relevant UKCA Directive requirements.

 Conformity with all relevant EC Directive requirements.

 This product is Class 1, must be connected to earth.

 Waste electrical products should not be disposed of with household waste. Please recycle where facilities exist. Check with your Local Authority or local store for recycling advice.

 This product is not suitable for dimming.

 This product is rated at IP20.

Duration: 3 hours (180 Minutes)
Operating Temperature: 0°C - 55°C
Mains input current: 22mA
input power in mains operation: 2.5W
Emergency power: 1W (Battery)
Battery Specification: LiFePO4 3.2V 1500mAH
Battery Charge Time: 24 Hours
Battery charge current: 200mA
Battery warranty: 2 years

Care and Safety

Live Voltages may be present in this unit even when turned off or when completely disconnected.

We recommend cleaning with a soft dry cloth. Do not use solvents or abrasive cleaners as these could damage the finish.

For your safety, always switch off the power supply before cleaning.

For further information, please visit <https://www.lighting-info.co.uk/107131>

V1 25/05/2023

UK Manufacturer: BH17 7BY

EU Manufacturer: Brilliant AG,
Brilliantstrasse 1, D-27442 Gnarenburg

saxby
lighting

Instruction manual

RularPRO EM

107141, 107142, 107143

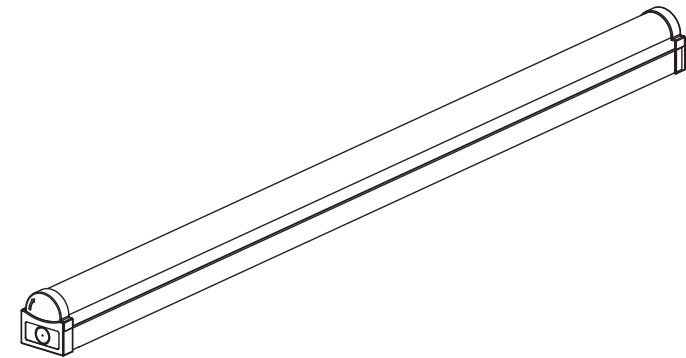

www.saxbylighting.com

saxby
lighting

Thank you for purchasing this light fitting. Please read the instructions carefully before use to ensure safe and satisfactory operation of this product. Please retain these instructions for future reference.

Warning

This is a Class 1 product and must be earthed.

Please read these instructions carefully before commencing any work.

This unit must be fitted by a competent and qualified electrician.

Check the pack and make sure you have all the parts listed.

Install in accordance with the IEE Wiring regulations and current Building Regulations.

To prevent electrocution switch off at mains supply before installing or maintaining this fitting. Ensure other persons cannot restore the electrical supply without your knowledge. If you are in any doubt, please consult a qualified electrician.

This light fitting should be connected to a fused circuit.

If replacing an existing fitting, make a careful note of the connections.

This product contains non-replaceable parts and cannot be serviced. If damage occurs the part should be scrapped.

Waste electrical products should not be disposed of with household waste. Please recycle where facilities exist. Check with your local authority or retailer for recycling advice.

Layout

Plan the desired layout of these fittings carefully, ensuring the cables will reach the distances between the junction box and the each light fitting.

Avoid locating any cables in positions that would cause a hazard. Position cables and outdoor rated junction boxes (not supplied) away from areas where they may be at risk from being cut, trapped or damaged.

The mains supply cable must have a minimum cross section area of 1.0mm².

Cables must be protected using suitable conduit or plastic trunking.

Take care not to drill into any pipes or mains cables beneath the surface during mounting holes preparation.

This product can be installed on the ceiling or wall.

Installation

Existing fittings must be completely removed before installation of a new product. Before removing the existing fitting, carefully note the position of each set of wires.

Note that the switch is turned off before installation.

The mounting surface must be flat and smooth to ensure a good fit.

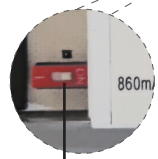

Wattage Switch

The wattage is changeable by using the wattage switch on the driver.

For the 107141 is the 31.5W / 20W selectable
20W 31.5W

For the 107142 is the 39W / 26W selectable
26W 39W

For the 107143 is the 44W / 35W selectable
35W 44W

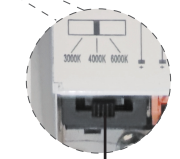

CCT Switch

The colour is changeable between 3000/4000/6000K using the CCT switch on the driver before installation. Choose your preferred wattage and colour before installing by wattage switch or CCT switch on the driver. Note: Before you change the wattage or colour, please turn off the power switch for safety.

- Hold the product in place and mark the position of the fixing holes. This may require the help of an assistant. If wall mounting, ensure that the product is level.
- Take care to avoid damaging any concealed wiring and pipes. The correct fixings should be used for bricks, cavity walls or plasterboard.
- Ensure the ceiling or wall is capable of holding the weight of the product and then fix brackets in place.
- Rotate both ends of the product in the direction of the arrow to open the diffuser cover.
- Pull the supply cable through the middle grommet and fix the light fitting into position using appropriate fixings.
- Connect the supply cable to the quick fit terminal block as detailed wiring diagram.
- Connect the battery output cable to the EM driver.
- Close diffuser cover into place.
- Replace fuse or circuit breaker and switch on. Your light is now ready for use.

