

Microwave Movement Sensor

This product is fitted with a microwave movement sensor. Please see below detailed operating instructions.

Technical Specifications:

Operating voltage	220 ~ 240V AC 50/60Hz	
Rated load	400W (Capacitive load) 800W (Resistive load)	
Stand-by power	≤ 0.5W	
Sensitivity	Ceiling mounted height: 3m	100% / 75% / 50% / 25% / 10%
	Ceiling mounted height: 6m*	100% / 75% / 50%
	Wall mounted height: 2m	100% / 75% / 50% / 25% / 10%
Hold-time	5s / 30s / 90s / 3min / 20min / 30min	
Daylight sensor	2Lux / 10Lux / 25Lux / 50Lux / Disable	
Microwave frequency	5.8 GHz ± 75MHz	
Transmitting power	1mW Max.	
Detection range	Ceiling mounted height: 3m	3- 6m (radius)
	Wall mounted height: 1.5-2m	12-15m
Detection angle	360° (Ceiling) / 120° (Wall)	
Working temperature	-20°C ~ 60°C	

*50%, 75%, 100% detection sensitivity is workable when installed at 6m mounting height. Only 10%, 25% sensitivity is not able to detect motion signal.

Settings:

<p>1. Sensitivity</p> <p>Sensitivity can be adjusted by selecting the combination on the DIP switches for different applications.</p> <table border="1"> <tr> <td>I – 100%</td> <td>1</td> <td>2</td> <td>3</td> <td></td> </tr> <tr> <td>II – 75%</td> <td>●</td> <td>●</td> <td>●</td> <td>100%</td> </tr> <tr> <td>III – 50%</td> <td>○</td> <td>●</td> <td>●</td> <td>75%</td> </tr> <tr> <td>IV – 25%</td> <td>●</td> <td>○</td> <td>●</td> <td>50%</td> </tr> <tr> <td>V – 10%</td> <td>○</td> <td>○</td> <td>●</td> <td>25%</td> </tr> <tr> <td></td> <td>○</td> <td>○</td> <td>○</td> <td>10%</td> </tr> </table>	I – 100%	1	2	3		II – 75%	●	●	●	100%	III – 50%	○	●	●	75%	IV – 25%	●	○	●	50%	V – 10%	○	○	●	25%		○	○	○	10%	<p>2. Hold-time</p> <p>Hold-time refers to the time period that the light remains 100% on if no more movement is detected.</p> <table border="1"> <tr> <td>I – 5s</td> <td>4</td> <td>5</td> <td>6</td> <td></td> </tr> <tr> <td>II – 30s</td> <td>●</td> <td>●</td> <td>●</td> <td>5s</td> </tr> <tr> <td>III – 90s</td> <td>○</td> <td>●</td> <td>●</td> <td>30s</td> </tr> <tr> <td>IV – 3min</td> <td>●</td> <td>○</td> <td>●</td> <td>90s</td> </tr> <tr> <td>V – 20min</td> <td>○</td> <td>○</td> <td>●</td> <td>3min</td> </tr> <tr> <td>VI – 30min</td> <td>●</td> <td>●</td> <td>○</td> <td>20min</td> </tr> <tr> <td></td> <td>○</td> <td>○</td> <td>○</td> <td>30min</td> </tr> </table>	I – 5s	4	5	6		II – 30s	●	●	●	5s	III – 90s	○	●	●	30s	IV – 3min	●	○	●	90s	V – 20min	○	○	●	3min	VI – 30min	●	●	○	20min		○	○	○	30min	<p>3. Daylight sensor</p> <p>Different daylight threshold can be preset on DIP switches. Light will always turn on upon movement if daylight sensor is disabled.</p> <table border="1"> <tr> <td>I – 2Lux</td> <td>7</td> <td>8</td> <td>9</td> <td></td> </tr> <tr> <td>II – 10Lux</td> <td>●</td> <td>●</td> <td>●</td> <td>2Lux</td> </tr> <tr> <td>III – 25Lux</td> <td>●</td> <td>●</td> <td>○</td> <td>10Lux</td> </tr> <tr> <td>IV – 50Lux</td> <td>○</td> <td>●</td> <td>○</td> <td>25Lux</td> </tr> <tr> <td>V – Disable</td> <td>●</td> <td>○</td> <td>○</td> <td>50Lux</td> </tr> <tr> <td></td> <td>○</td> <td>○</td> <td>○</td> <td>Disable*</td> </tr> </table> <p>*Disable means the daylight sensor does not work. The sensor will turn on light once motion is detected regardless of ambient light level.</p>	I – 2Lux	7	8	9		II – 10Lux	●	●	●	2Lux	III – 25Lux	●	●	○	10Lux	IV – 50Lux	○	●	○	25Lux	V – Disable	●	○	○	50Lux		○	○	○	Disable*
I – 100%	1	2	3																																																																																														
II – 75%	●	●	●	100%																																																																																													
III – 50%	○	●	●	75%																																																																																													
IV – 25%	●	○	●	50%																																																																																													
V – 10%	○	○	●	25%																																																																																													
	○	○	○	10%																																																																																													
I – 5s	4	5	6																																																																																														
II – 30s	●	●	●	5s																																																																																													
III – 90s	○	●	●	30s																																																																																													
IV – 3min	●	○	●	90s																																																																																													
V – 20min	○	○	●	3min																																																																																													
VI – 30min	●	●	○	20min																																																																																													
	○	○	○	30min																																																																																													
I – 2Lux	7	8	9																																																																																														
II – 10Lux	●	●	●	2Lux																																																																																													
III – 25Lux	●	●	○	10Lux																																																																																													
IV – 50Lux	○	●	○	25Lux																																																																																													
V – Disable	●	○	○	50Lux																																																																																													
	○	○	○	Disable*																																																																																													

Trouble shooting:

Malfunction	Cause	Remedy
The light will not come on	Incorrect light-control setting selected	Adjust daylight threshold setting
	Faulty lamp	Replace lamp
	No power supply	Check power to sensor
The lamp is always on	Continuous movement in the detection zone	Check detection area setting
The lamp is on without any identifiable movement	The sensor is not mounted for reliably detecting movement	Securely mount enclosure
	Movement occurred, but not identified by the sensor (Movement behind wall, movement of small object in immediate lamp vicinity etc.)	1. Reduce sensitivity. 2. Check the movement behind walls to avoid facilities such as water pipe, fan, which may mis-trigger the sensor.
The lamp will not work despite movement	Rapid movements are being suppressed to minimize malfunctioning or the detection radius is too small.	Check detection area setting

Care and Safety

We recommend cleaning with a soft dry cloth. Do not use solvents or abrasive cleaners as these could damage the finish.

For your safety, always switch off the power supply before cleaning.

For further information, please visit <https://www.lighting-info.co.uk/95541>

V8 12/01/2026

UK Manufacturer: BH17 7BY

EU Manufacturer: Brilliant AG,

Brilliantstrasse 1, D-27442 Gnarrenburg

saxby
lighting

Instruction manual

HeroPro CCT Microwave

95541, 103939

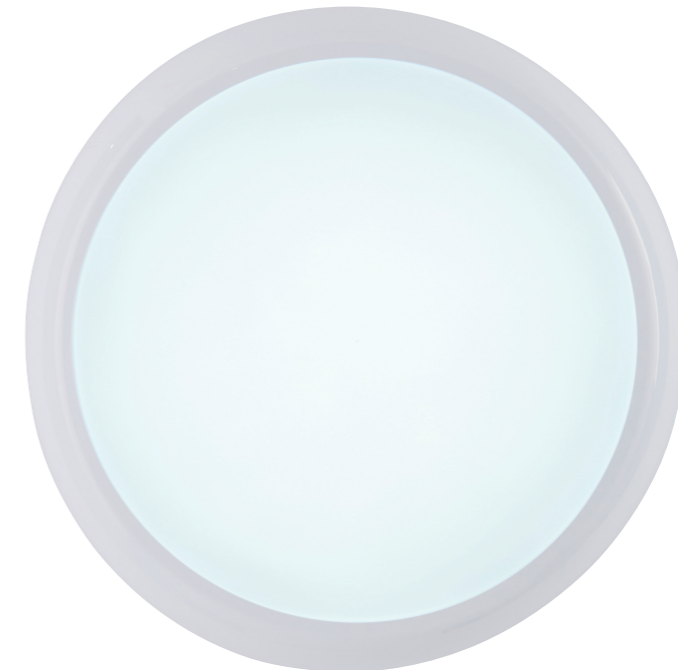
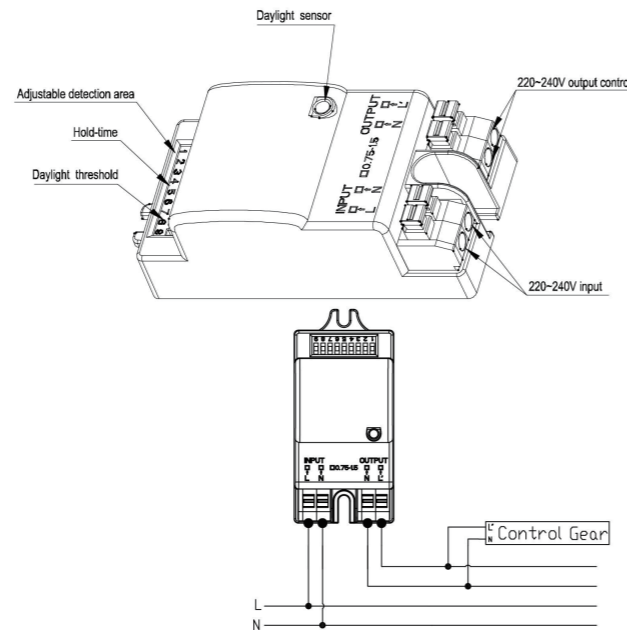

www.saxbylighting.com

saxby
lighting

Thank you for purchasing this light fitting. Please read the instructions carefully before use to ensure safe and satisfactory operation of this product. Please retain these instructions for future reference.

Warning

 This light fitting is double insulated and does not require connection to an earth circuit.

Please read these instructions carefully before commencing any work.

This unit must be fitted by a competent and qualified electrician.

Install in accordance with the IET Wiring regulations and current Building Regulations.

Check the pack and make sure you have all the parts listed.

To prevent electrocution switch off at the mains supply before installing or maintaining this fitting. Ensure other persons cannot restore the electrical supply without your knowledge.

If you are in any doubt, please consult a qualified electrician.

This light fitting should be connected to a fused circuit.

If replacing an existing fitting, make a careful note of the connections.

Waste electrical products should not be disposed of with household waste. Please recycle where facilities exist. Check with your local authority or retailer for recycling advice.

Technical data

Supply Voltage: 220-240 V~, 50 Hz

Bulb Type: 95541---18/14/9W LED module (SMD) CCT, 3000/4000/6000K
103939---28/24/20W LED module (SMD) CCT, 3000/4000/6000K

This product contains a light source of energy efficiency class **D**.

  Non-replaceable light source |  Replaceable control gear by a professional

 Conformity with all relevant UKCA Directive requirements.

 Conformity with all relevant EC Directive requirements.

 The power supply is Double Insulated and does not require connection to an Earth circuit.

 Waste electrical products should not be disposed of with household waste. Please recycle where facilities exist. Check with your Local Authority or local store for recycling advice.

 This product is not suitable for dimming.

 This product is rated at IP65

 This product is rated at IK10 for 95541.

 This product is rated at IK08 for 103939.

Layout

Plan the desired layout of these fittings carefully, ensuring the cables will reach the distances between each light fitting.

Avoid locating any cables in positions that would cause a hazard. Position cables and junction boxes (not supplied) away from areas where they may be at risk from being cut, trapped or damaged.

The mains supply cable must have a minimum cross section area of 1.0mm². Cables must be protected using suitable conduit or plastic trunking.

The products can be wall or ceiling mounted. If wall mounting ensure that the power supply is at the bottom.

Installation

Existing fittings must be completely removed before installation of a new product. Before removing the existing fitting, carefully note the position of each set of wires. Note the switch is turned off before installation.

The ceiling surface must be flat and smooth to ensure a good fit.

Ensure that the screws and cable entry points are sealed to maintain the IP rating of the product.

- Twist and remove the lamp cover from the product, keep safe for refitting later.
- Turn the clip to loose the LED tray in the rear casing.
- Using the rear casing as a template mark the position to drill out the fixing holes. Take care to avoid damaging any concealed wiring and pipes.
- Fix the rear casing into the position using the installation plugs and screws.
- Pull the cable through the cable entry hole and seal to maintain the IP rating and wire as detailed Wiring Diagram.
- Refit the LED tray back into the rear casing and lock the clip.
- Twist the lamp cover back onto the product and lock in place.
- Replace fuse or circuit breaker and switch on. Your light is now ready for use.

The wattage is changeable between the different wattage using the wattage switch on the driver before installation.

 For the 95541 is the 18W/14W/9W selectable

 For the 103939 is the 28W/24W/20W selectable

 6000K 4000K 3000K The colour is changeable between 3000/4000/6000K using the CCT switch on the driver before installation.

Choose your preferred wattage and colour before installing by wattage switch or CCT switch on the driver.
Note: Before you change the wattage or colour, please turn off the power for safety.

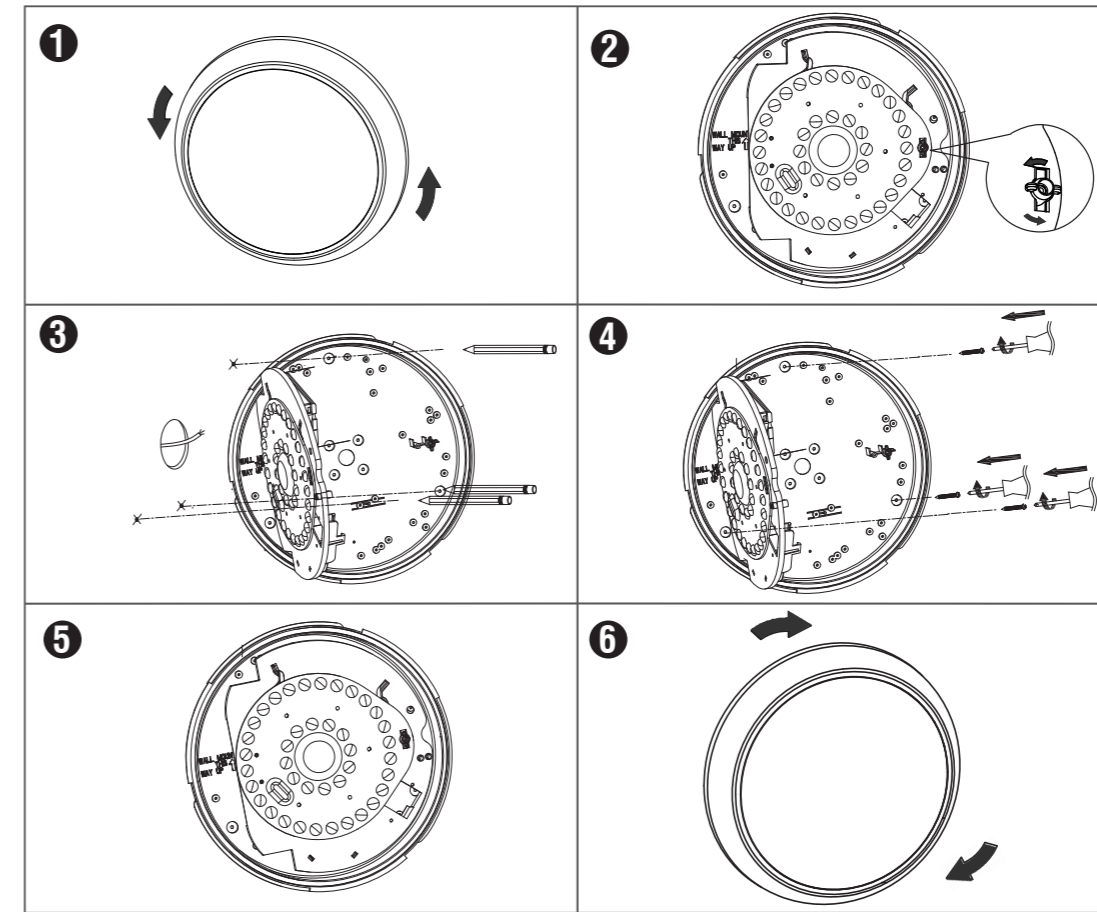

* Product images may vary.

Bezels for 95541 only

The following individual casings are available for purchase separately.

95545 : Chrome plain
95546 : White eyelid
95547 : White grill

95548 : Black plain
95549 : Black eyelid
95550 : Black grill

95551 : Anthracite grey plain
95552 : Anthracite grey eyelid
95553 : Anthracite grey grill

Wiring

Having correctly identified the wiring from your existing light fitting, pull the mains wire through the hole and connect to the quick fit connection block in the following way. No tools are necessary.

Wiring 1 Master-Slave

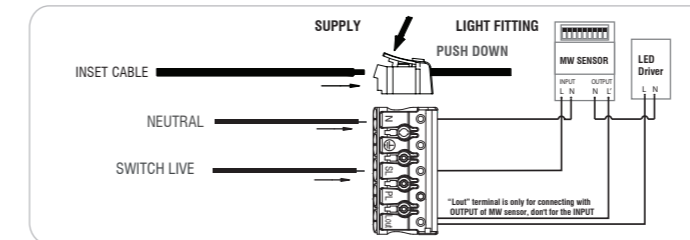

Wiring 2 On its own

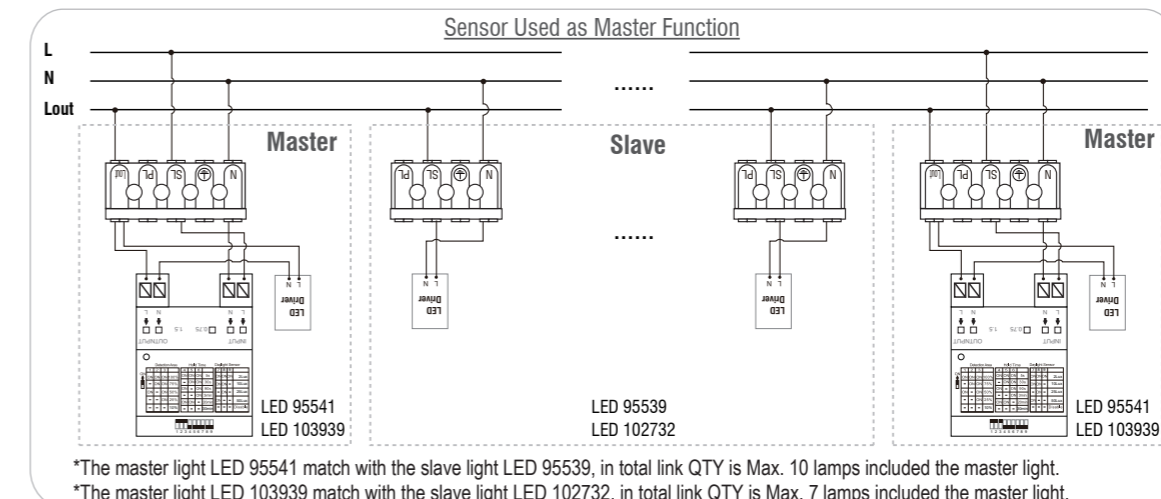
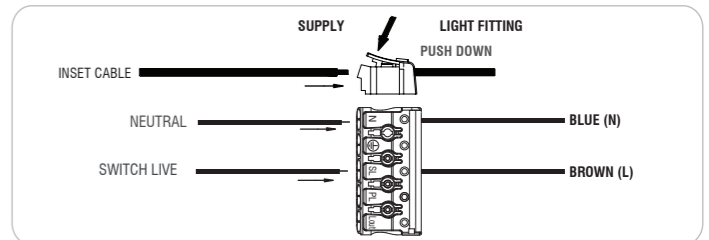

*The master light LED 95541 match with the slave light LED 95539, in total link QTY is Max. 10 lamps included the master light.
*The master light LED 103939 match with the slave light LED 102732, in total link QTY is Max. 7 lamps included the master light.

Check that...

You have correctly identified the wires.
The connections are tight.
No loose strands have been left out of the connection block.